



INSTALLATION INSTRUCTIONS
COLD AIR INTAKE KIT
2005-2008 DODGE Magnum / 2005-2009 CHRYSLER 300 3.5L V6
2006-2009 DODGE Charger 3.5L V6
2009 Dodge Challenger 3.5L V6
PART NUMBER 77060019AB

Bill of Materials for 77060019AB

Part Number	Description	Qty
2-82131M	INLET PIPE	1
103-BLO-5220N	#52 FILTER CLAMP	1
77070011	3.00" FILTER ELEMENT	1
1228560	8MM RUBBER MOUNT	1
559960	8MM WASHER	2
103-BLO-4820N	#48 HOSE CLAMP	2
99024.032	PCV BREATHER HOSE CLAMP	1
20-8213	HEAT SHIELD	1
8-119	FOAM RUBBER GASKET	9
8-149	PUSH-IN CLIP	1
5-302	COUPLER	1
444.460.08	8MM NUTS	2
K6857145	INSTRUCTIONS	1
784634	1/2" GROMMET	1
8-111	RUBBER EDGE TRIM	13



IMPORTANT:

This kit includes a Dry Filter. **DO NOT APPLY ANY OIL TO THIS FILTER!** See step 5 for cleaning instructions.

Read and understand these instructions **BEFORE** attempting to install this product.

1) Getting Started

- a) Make sure vehicle is parked on a level surface.
- b) Set parking brake.
- c) If engine has run with in the past two hours let it cool down.
- d) Disconnect negative battery terminal.



INSTALLATION INSTRUCTIONS
COLD AIR INTAKE KIT
2005-2008 DODGE Magnum / 2005-2009 CHRYSLER 300 3.5L V6
2006-2009 DODGE Charger 3.5L V6
2009 Dodge Challenger 3.5L V6
PART NUMBER 77060019AB

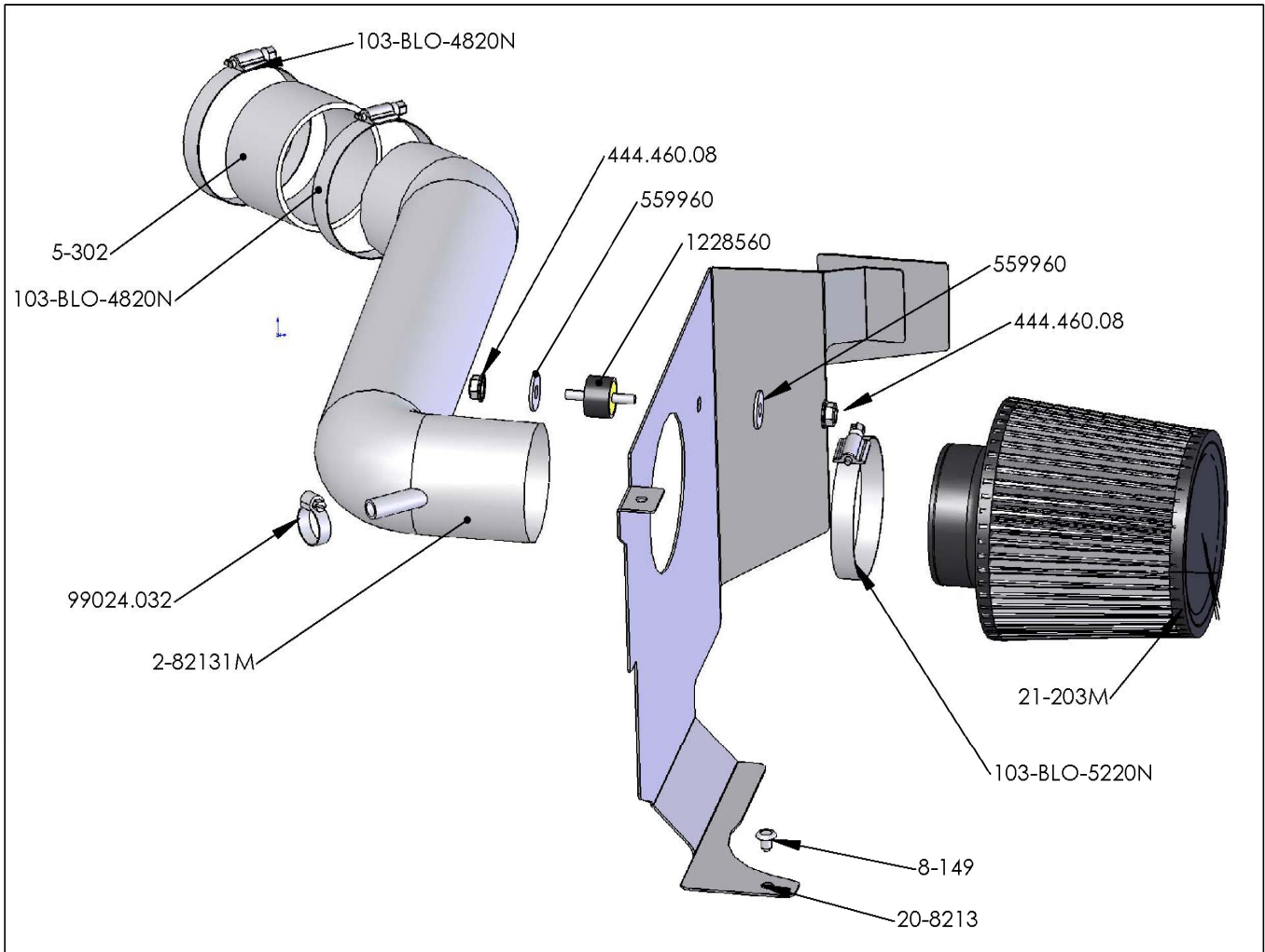



INSTALLATION INSTRUCTIONS
COLD AIR INTAKE KIT
2005-2008 DODGE Magnum / 2005-2009 CHRYSLER 300 3.5L V6
2006-2009 DODGE Charger 3.5L V6
2009 Dodge Challenger 3.5L V6
PART NUMBER 77060019AB

2) Removal of the stock intake system



a) Disconnect the Inlet Air Temperature (IAT) Sensor connector.



b) Loosen hose clamp at the throttle body.



c) Remove the PCV breather tube from the air box.

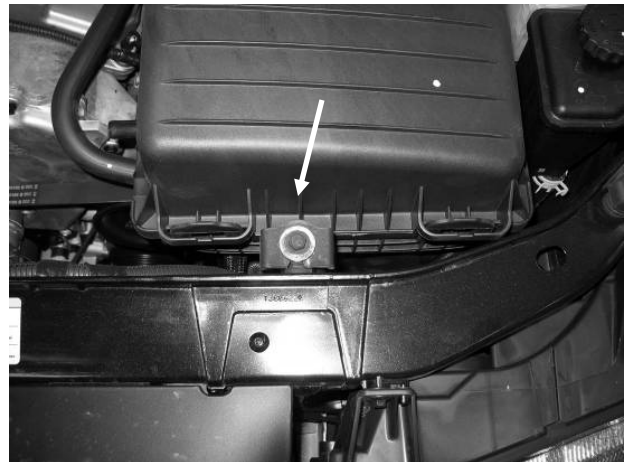

d) Loosen and remove the air box mounting screw. This screw will be reused.



INSTALLATION INSTRUCTIONS
COLD AIR INTAKE KIT

2005-2008 DODGE Magnum / 2005-2009 CHRYSLER 300 3.5L V6

2006-2009 DODGE Charger 3.5L V6

2009 Dodge Challenger 3.5L V6

PART NUMBER 77060019AB



e) Remove the coolant line from the air tube.



f) Remove the air box assembly from the engine bay.

3) Installation of the **MOPAR Cold Air Intake System**

- a) When installing the MOPAR Cold Air Intake System, DO NOT completely tighten the hose clamps or mounting tab hardware until instructed to do so later in these instructions.

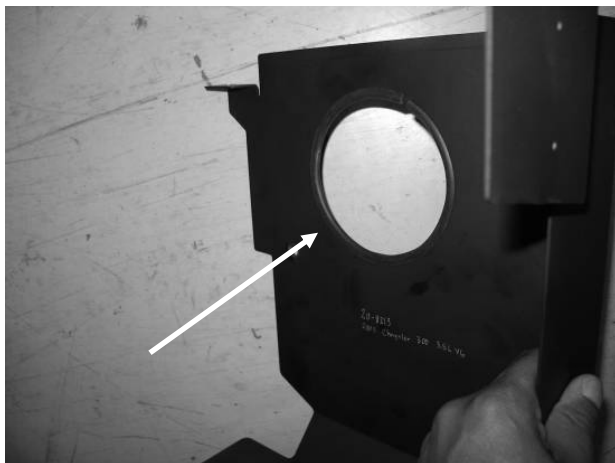

b) Attach the rubber edge trim to the inlet pipe opening on the heat shield.



c) Attach the foam gasket onto the top of the heat shield.



INSTALLATION INSTRUCTIONS
COLD AIR INTAKE KIT
2005-2008 DODGE Magnum / 2005-2009 CHRYSLER 300 3.5L V6
2006-2009 DODGE Charger 3.5L V6
2009 Dodge Challenger 3.5L V6
PART NUMBER 77060019AB



d) Insert the heat shield as shown. The vertical tab slides into the coolant reservoir. The bottom tab slides underneath the coolant and vacuum lines.

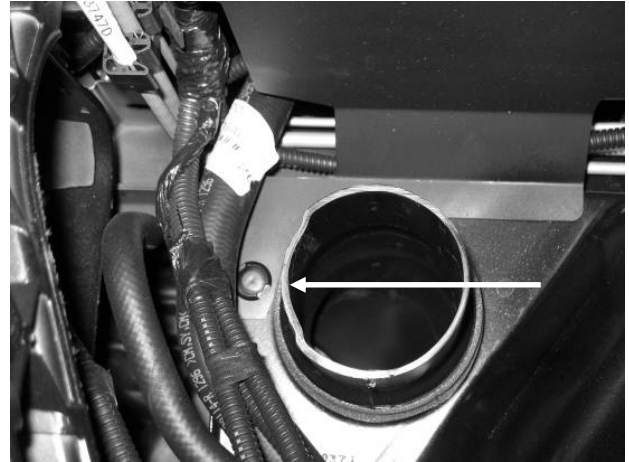

e) Insert the push-in clip on the heat shield base to secure.



f) Secure the remaining tab with the factory screw.



g) Insert the rubber mount as shown.



INSTALLATION INSTRUCTIONS
COLD AIR INTAKE KIT

2005-2008 DODGE Magnum / 2005-2009 CHRYSLER 300 3.5L V6

2006-2009 DODGE Charger 3.5L V6

2009 Dodge Challenger 3.5L V6

PART NUMBER 77060019AB

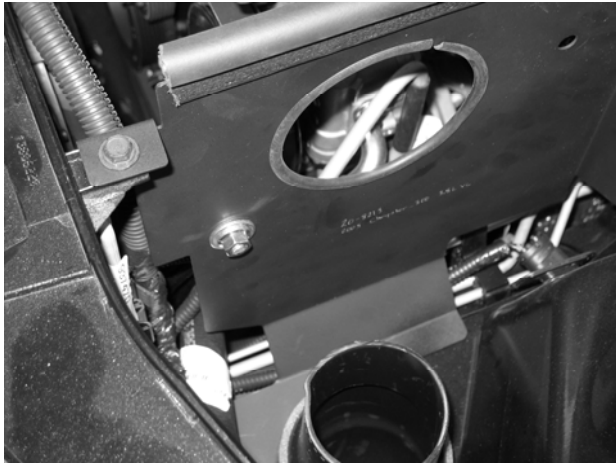

h) Secure the rubber mount with the M8 Washer and Nut.



i) Attach the coupler to the throttle body and secure with provided hose clamps.



j) Insert the inlet pipe as shown. Align the bracket with the rubber mount.



INSTALLATION INSTRUCTIONS
COLD AIR INTAKE KIT
2005-2008 DODGE Magnum / 2005-2009 CHRYSLER 300 3.5L V6
2006-2009 DODGE Charger 3.5L V6
2009 Dodge Challenger 3.5L V6
PART NUMBER 77060019AB

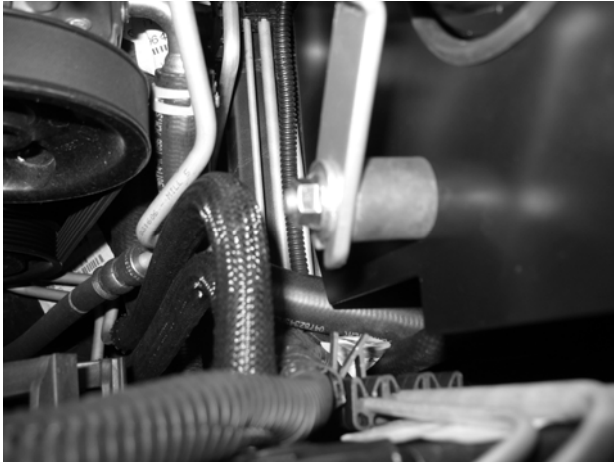

k) Once the bracket is aligned, check for clearance around the rubber edge trim. Secure bracket with M8 Washer and Nut.

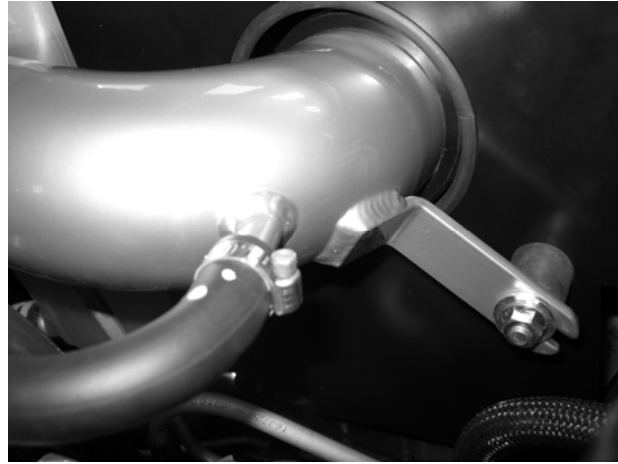

l) Reattach the PCV breather hose to the breather nipple on the inlet pipe. Secure with hose clamp.

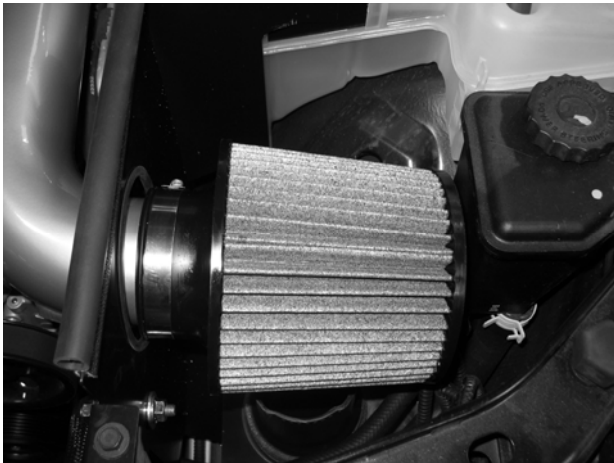

m) Attach the dry filter element. Check for clearance around the rubber edge trim and secure.

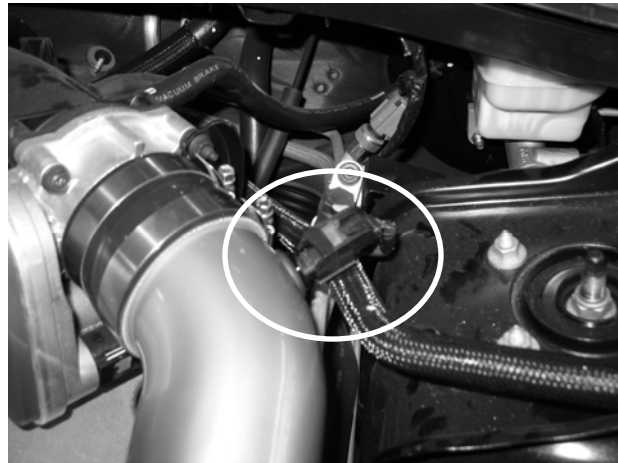

n) Insert grommet and then the IAT sensor. Reattach the IAT sensor harness connector. Secure the inlet pipe at the throttle body coupler.



INSTALLATION INSTRUCTIONS
COLD AIR INTAKE KIT
2005-2008 DODGE Magnum / 2005-2009 CHRYSLER 300 3.5L V6
2006-2009 DODGE Charger 3.5L V6
2009 Dodge Challenger 3.5L V6
PART NUMBER 77060019AB



Your MOPAR Cold Air Intake should look like this.

4) Re-assemble the vehicle

- a) Position the filter for best fitment. Be sure that the filter, tube, or any other components do not contact the heat shield or any part of the vehicle.
- b) Tighten all hose clamps.
- c) Tighten the bolts and nuts on the mounting bracket and heat shield.
- d) Inspect the engine bay for any loose tools and check that all fasteners that were moved or removed are tight.
- e) Start engine and perform a final inspection before driving the vehicle.



INSTALLATION INSTRUCTIONS
COLD AIR INTAKE KIT
2005-2008 DODGE Magnum / 2005-2009 CHRYSLER 300 3.5L V6
2006-2009 DODGE Charger 3.5L V6
2009 Dodge Challenger 3.5L V6
PART NUMBER 77060019AB

5) Dry Filter cleaning procedure

- Remove filter from intake pipe and set the filter clamp aside.
- Measure the length of the filter media.
- Fill a pail with warm clean water to the depth determined in Step b. Add a mild household detergent to the water.
- Without allowing the solution to flow into the filter neck, submerge the filter into the water and let it soak for 10 minutes. After soaking, rotate the filter back and forth to agitate the water and knock off dirt.
- Empty the bucket of dirty water. Repeat steps C and D.
- Refill the pail with clean warm water and rinse by rotating the filter as in step D. The water should be clear with no signs of dirt in the pail.
- Allow the filter to air dry. **DO NOT APPLY ANY OIL TO THIS FILTER.** Re-install the filter on the intake system once it is dry.

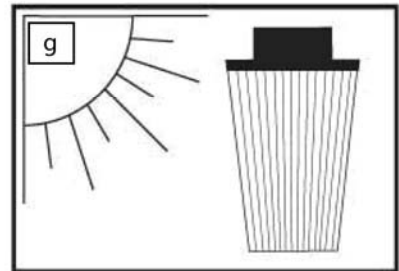
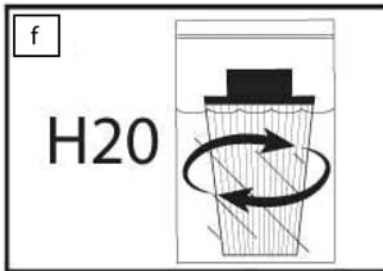
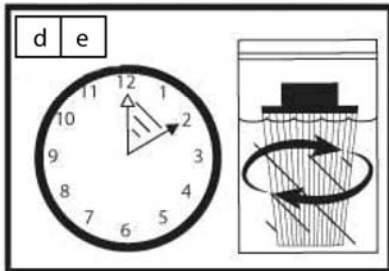
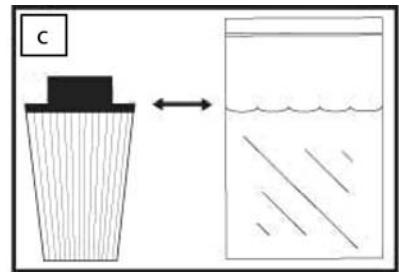
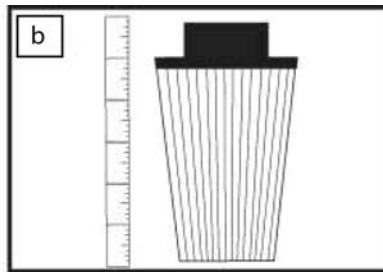
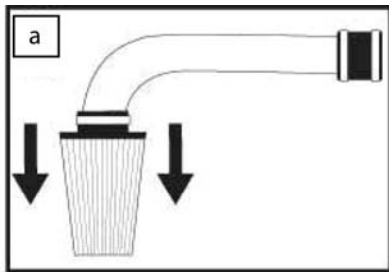

For technical assistance regarding MOPAR Cold Air Intake Systems, please call toll-free 1-888-528-HEMI (528-4364).